

# **Armadillo-400 Series Revision Information**

**Armadillo-420 A4200/A4201/A4202**

**Armadillo-440 A4400**

**Armadillo-460 A4600/A4601**

**LCD Expansion Board OP-A400-LCD43EXT-L01**

**RTC Option Module OP-A400-RTCMOD-00/OP-A400-RTCMOD-01**

**WLAN Option Module OP-A400-AWLMOD-00/OP-A400-AWLMOD-10**

**Version 1.3.0**

**2012/02/29**

**Atmark Techno, Inc**

**Armadillo Site**

---

## **Armadillo-400 Series Revision Information**

Atmark Techno, Inc

060-0035 AFT Bldg., N5E2, Chuo-ku, Sapporo  
TEL 011-207-6550 FAX 011-207-6570

Copyright © 2010-2012 Atmark Techno, Inc

Version 1.3.0  
2012/02/29

---

# Table of Contents

- 1. Preface ..... 6
  - 1.1. Covered Products ..... 6
  - 1.2. Determining the Product Revision ..... 6
    - 1.2.1. Armadillo-420: Determining Product Revision ..... 6
    - 1.2.2. Armadillo-440: Determining Product Revision ..... 7
    - 1.2.3. Armadillo-460: Determining Product Revision ..... 8
    - 1.2.4. Armadillo-400 Series RTC Option Module (Product ID: OP-A400-RTCMOD-00): Determining Product Revision ..... 9
    - 1.2.5. Armadillo-400 Series RTC Option Module (Product ID: OP-A400-RTCMOD-01): Determining Product Revision ..... 9
    - 1.2.6. Armadillo-400 Series LCD Expansion Board: Determining Product Revision ..... 10
    - 1.2.7. Armadillo-400 Series WLAN Option Module (AWL12 Compatible): Determining Product Revision ..... 11
    - 1.2.8. Armadillo-400 Series WLAN Option Module (AWL13 Compatible): Determining Product Revision ..... 12
- 2. Armadillo-420: Errata ..... 14
  - 2.1. Product Revision A ..... 14
    - 2.1.1. A420-Erratum #1: Current is Supplied to Connected USB Devices Even When PMIC is in OFF State ..... 14
  - 2.2. Product Revision B ..... 14
  - 2.3. Product Revision C ..... 14
  - 2.4. Product Revision D ..... 14
  - 2.5. Product Revision E ..... 14
- 3. Armadillo-420: Revision History ..... 15
  - 3.1. Changes from Product Revision A to B ..... 15
    - 3.1.1. USB and microSD Power Switch Changed ..... 15
  - 3.2. Changes from Product Revision B to C ..... 15
    - 3.2.1. Changed to Eight Layer Board ..... 15
    - 3.2.2. microSD Power Switch Changed ..... 15
    - 3.2.3. Hardware ID Changed to 0x0302 ..... 16
  - 3.3. Changes from Product Revision C to D ..... 16
    - 3.3.1. USB and microSD Power Switch Changed ..... 16
  - 3.4. Changes from Product Revision D to E ..... 16
    - 3.4.1. Mounting Factory Changed ..... 16
- 4. Armadillo-440: Errata ..... 17
  - 4.1. Product Revision A ..... 17
    - 4.1.1. A440-Erratum #1: Current is Supplied to Connected USB Devices Even When PMIC is in OFF State ..... 17
  - 4.2. Product Revision B ..... 17
  - 4.3. Product Revision C ..... 17
  - 4.4. Product Revision D ..... 17
  - 4.5. Product Revision E ..... 17
  - 4.6. Product Revision F ..... 18
- 5. Armadillo-440: Revision History ..... 19
  - 5.1. Changes from Product Revision A to B ..... 19
    - 5.1.1. Test Pad Added ..... 19
    - 5.1.2. Hardware ID Changed to 0x0301 ..... 19
  - 5.2. Changes from Product Revision B to C ..... 19
    - 5.2.1. USB and microSD Power Switch Changed ..... 19
  - 5.3. Changes from Product Revision C to D ..... 20
    - 5.3.1. Changed to Eight Layer Board ..... 20
    - 5.3.2. microSD Power Switch Changed ..... 20
    - 5.3.3. Hardware ID Changed to 0x0302 ..... 20

- 5.4. Changes from Product Revision D to E ..... 20
  - 5.4.1. USB and microSD Power Switch Changed ..... 21
- 5.5. Changes from Product Revision E to F ..... 21
  - 5.5.1. Mounting Factory Changed ..... 21
- 6. Armadillo-460: Errata ..... 22
  - 6.1. Product Revision A ..... 22
    - 6.1.1. A460-Erratum #1: Current is Supplied to Connected USB Devices Even When PMIC is in OFF State ..... 22
  - 6.2. Product Revision B ..... 22
- 7. Armadillo-460: Revision History ..... 23
  - 7.1. Changes from Product Revision A to B ..... 23
    - 7.1.1. Mounting Factory Changed ..... 23
- 8. Armadillo-400 Series RTC Option Module (Product ID: OP-A400-RTCMOD-00): Errata ..... 24
  - 8.1. Product Revision A ..... 24
- 9. Armadillo-400 Series RTC Option Module (Product ID: OP-A400-RTCMOD-00): Revision History ..... 25
- 10. Armadillo-400 Series RTC Option Module (Product ID: OP-A400-RTCMOD-01): Errata ..... 26
  - 10.1. Product Revision A ..... 26
- 11. Armadillo-400 Series RTC Option Module (Product ID: OP-A400-RTCMOD-01): Revision History ..... 27
- 12. Armadillo-400 Series LCD Expansion Board: Errata ..... 28
  - 12.1. Product Revision A ..... 28
    - 12.1.1. A400-LCD-Erratum #1: I2C Bus Becomes Unusable ..... 28
    - 12.1.2. A400-LCD-Erratum #2: i.MX257 AD Input Terminals Sustains Damage ..... 29
  - 12.2. Product Revision B ..... 30
    - 12.2.1. A400-LCD-Erratum #3: Cannot Sleep When Used with linux-2.6.26-at13 and Previous Kernels ... 31
    - 12.2.2. A400-LCD-Erratum #4: A Discrepancy in the Touchscreen Coordinates Occurs ..... 31
- 13. Armadillo-400 Series LCD Expansion Board: Revision History ..... 33
  - 13.1. Changes from Product Revision A to B ..... 33
    - 13.1.1. A400-LCD-Erratum #1 Measures ..... 33
    - 13.1.2. A400-LCD-Erratum #2 Measures ..... 33
    - 13.1.3. RTC Backup Part Changed ..... 33
- 14. Armadillo-400 Series WLAN Option Module (AWL12 Compatible): Errata ..... 35
  - 14.1. Product Revision A ..... 35
- 15. Armadillo-400 Series WLAN Option Module (AWL12 Compatible): Revision History ..... 36
- 16. Armadillo-400 Series WLAN Option Module (AWL13 Compatible): Errata ..... 37
  - 16.1. Product Revision A ..... 37
- 17. Armadillo-400 Series WLAN Option Module (AWL13 Compatible): Revision History ..... 38

# List of Figures

- 1.1. Armadillo-420 Lot Sticker Position ..... 6
- 1.2. Armadillo-420 Lot Sticker Format ..... 7
- 1.3. Armadillo-440 Lot Sticker Position ..... 7
- 1.4. Armadillo-440 Lot Sticker Format ..... 7
- 1.5. Armadillo-460 Lot Sticker Position ..... 8
- 1.6. Armadillo-460 Lot Sticker Format ..... 8
- 1.7. Armadillo-400 Series RTC Option Module (Product ID: OP-A400-RTCMOD-00) Lot Sticker Position ..... 9
- 1.8. Armadillo-400 Series RTC Option Module (Product ID: OP-A400-RTCMOD-00) Lot Sticker Format ..... 9
- 1.9. Armadillo-400 Series RTC Option Module (Product ID: OP-A400-RTCMOD-01) Lot Sticker Position ..... 9
- 1.10. Armadillo-400 Series RTC Option Module (Product ID: OP-A400-RTCMOD-01) Lot Sticker Format ..... 10
- 1.11. Armadillo-400 Series LCD Expansion Board Lot Sticker Position ..... 10
- 1.12. Armadillo-400 Series LCD Expansion Board Lot Sticker Format ..... 10
- 1.13. Armadillo-WLAN Module (AWL12) Lot Sticker Position ..... 11
- 1.14. Armadillo-WLAN Option Module (AWL12) Lot Sticker Format ..... 11
- 1.15. Armadillo-400 Series WLAN Interface Board (AWL12 Compatible) Lot Sticker Position ..... 11
- 1.16. Armadillo-400 Series WLAN Interface Board (AWL12 Compatible) Lot Sticker Format ..... 12
- 1.17. Armadillo-WLAN Module (AWL13) Lot Sticker Position ..... 12
- 1.18. Armadillo-WLAN Module (AWL13) Lot Sticker Format ..... 12
- 1.19. Armadillo-400 Series WLAN Interface Board (AWL13 Compatible) Lot Sticker Position ..... 13
- 1.20. Armadillo-400 Series WLAN Interface Board (AWL13 Compatible) Lot Sticker Format ..... 13
- 12.1. Recommended Circuit Measures for Crosstalk Noise ..... 28
- 12.2. Recommended Circuit Measures for ESD ..... 29

# Chapter 1. Preface

---

This document contains the revision information of the Armadillo-400 Series and related products as at the time of writing. The revision information is based around the "Product Revision".



The silkscreen "Rev. X" marking printed on the board is the board (PCB) revision. The board revision differs to the product revision.

## 1.1. Covered Products

This document covers the following Armadillo-400 Series and related products.

- Armadillo-420
- Armadillo-440
- Armadillo-460
- Armadillo-400 Series RTC Option Module (Product ID: OP-A400-RTCMOD-00)
- Armadillo-400 Series RTC Option Module (Product ID: OP-A400-RTCMOD-01)
- Armadillo-400 Series LCD Expansion Board
- Armadillo-400 Series WLAN Option Module (AWL12 Compatible)
- Armadillo-400 Series WLAN Option Module (AWL13 Compatible)

## 1.2. Determining the Product Revision

### 1.2.1. Armadillo-420: Determining Product Revision

The product revision can be determined from the lot number. The lot number can be found on the lot sticker attached to the Armadillo-420 board. Please see Figure 1.1, "Armadillo-420 Lot Sticker Position" for the position of the lot sticker.

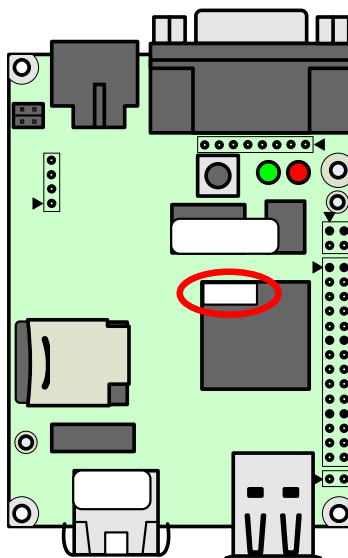

**Figure 1.1. Armadillo-420 Lot Sticker Position**

Of the six digits on the lot sticker, the middle two digits are the lot number. Please see Figure 1.2, “Armadillo-420 Lot Sticker Format” for the position of the lot number. The lot number is written in hexadecimal.



**Figure 1.2. Armadillo-420 Lot Sticker Format**

Please determine the product revision from the lot number using the table below.

Product Revision	Lot Number
A	01 - 06
B	07
C	08 - 13
D	14, 15
E	16 and later

### 1.2.2. Armadillo-440: Determining Product Revision

The product revision can be determined from the lot number. The lot number can be found on the lot sticker attached to the Armadillo-440 board. Please see Figure 1.3, “Armadillo-440 Lot Sticker Position” for the position of the lot sticker.

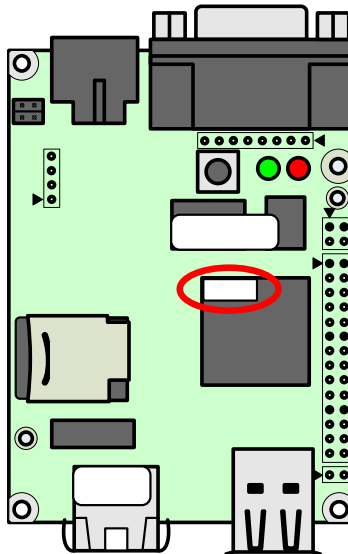

**Figure 1.3. Armadillo-440 Lot Sticker Position**

Of the six digits on the lot sticker, the middle two digits are the lot number. Please see Figure 1.4, “Armadillo-440 Lot Sticker Format” for the position of the lot number. The lot number is written in hexadecimal.



**Figure 1.4. Armadillo-440 Lot Sticker Format**

Please determine the product revision from the lot number using the table below.

Product Revision	Lot Number
A	01
B	02 - 11
C	12
D	13 - 16, 18
E	17, 19, 1A
F	1B and later

### 1.2.3. Armadillo-460: Determining Product Revision

The product revision can be determined from the lot number. The lot number can be found on the lot sticker attached to the Armadillo-460 board. Please see Figure 1.5, “Armadillo-460 Lot Sticker Position” for the position of the lot sticker.

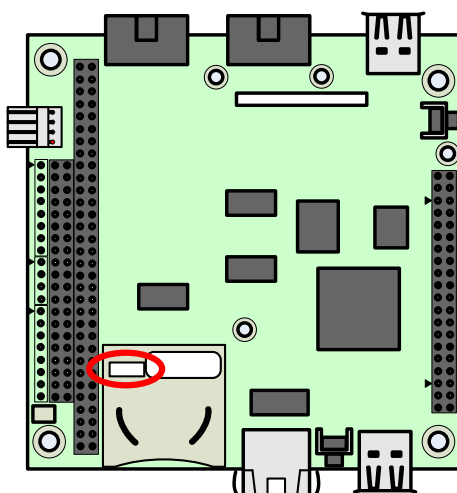

Figure 1.5. Armadillo-460 Lot Sticker Position

Of the six digits on the lot sticker, the middle two digits are the lot number. Please see Figure 1.6, “Armadillo-460 Lot Sticker Format” for the position of the lot number. The lot number is written in hexadecimal.



Figure 1.6. Armadillo-460 Lot Sticker Format

Please determine the product revision from the lot number using the table below.

Product Revision	Lot Number
A	01 - 02
B	03 and later



### 1.2.4. Armadillo-400 Series RTC Option Module (Product ID: OP-A400-RTCMOD-00): Determining Product Revision

The product revision can be determined from the lot number. The lot number can be found on the lot sticker attached to the Armadillo-400 Series RTC Option Module (Product ID: OP-A400-RTCMOD-00). Please see Figure 1.7, “Armadillo-400 Series RTC Option Module (Product ID: OP-A400-RTCMOD-00) Lot Sticker Position” for the position of the lot sticker.

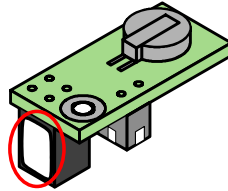

**Figure 1.7. Armadillo-400 Series RTC Option Module (Product ID: OP-A400-RTCMOD-00) Lot Sticker Position**

Of the six digits separated by a hyphen on the lot sticker, the left two digits are the lot number. Please see Figure 1.8, “Armadillo-400 Series RTC Option Module (Product ID: OP-A400-RTCMOD-00) Lot Sticker Format” for the position of the lot number. The lot number is written in hexadecimal.

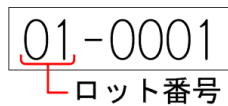

**Figure 1.8. Armadillo-400 Series RTC Option Module (Product ID: OP-A400-RTCMOD-00) Lot Sticker Format**

Please determine the product revision from the lot number using the table below.

Product Revision	Lot Number
A	01 and later

### 1.2.5. Armadillo-400 Series RTC Option Module (Product ID: OP-A400-RTCMOD-01): Determining Product Revision

The product revision can be determined from the lot number. The lot number can be found on the lot sticker attached to the Armadillo-400 Series RTC Option Module (Product ID: OP-A400-RTCMOD-01). Please see Figure 1.9, “Armadillo-400 Series RTC Option Module (Product ID: OP-A400-RTCMOD-01) Lot Sticker Position” for the position of the lot sticker.

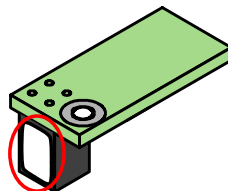

**Figure 1.9. Armadillo-400 Series RTC Option Module (Product ID: OP-A400-RTCMOD-01) Lot Sticker Position**

Of the six digits separated by a hyphen on the lot sticker, the left two digits are the lot number. Please see Figure 1.10, “Armadillo-400 Series RTC Option Module (Product ID: OP-A400-RTCMOD-01) Lot Sticker Format” for the position of the lot number. The lot number is written in hexadecimal.

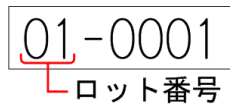

**Figure 1.10. Armadillo-400 Series RTC Option Module (Product ID: OP-A400-RTCMOD-01) Lot Sticker Format**

Please determine the product revision from the lot number using the table below.

Product Revision	Lot Number
A	01 and later

### 1.2.6. Armadillo-400 Series LCD Expansion Board: Determining Product Revision

The product revision can be determined from the lot number. The lot number can be found on the lot sticker attached to the Armadillo-400 Series LCD Expansion Board. Please see Figure 1.11, “Armadillo-400 Series LCD Expansion Board Lot Sticker Position” for the position of the lot sticker.

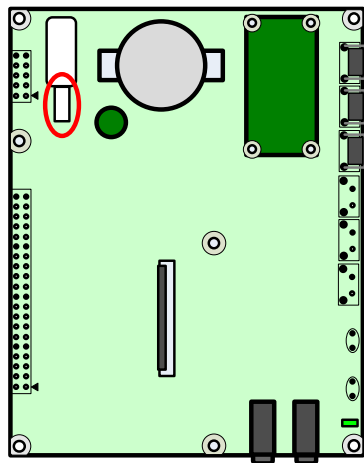

**Figure 1.11. Armadillo-400 Series LCD Expansion Board Lot Sticker Position**

Of the six digits on the lot sticker, the middle two digits are the lot number. Please see Figure 1.12, “Armadillo-400 Series LCD Expansion Board Lot Sticker Format” for the position of the lot number. The lot number is written in hexadecimal.



**Figure 1.12. Armadillo-400 Series LCD Expansion Board Lot Sticker Format**

Please determine the product revision from the lot number using the table below.

Product Revision	Lot Number
A	01 - 05
B	06 and later

### 1.2.7. Armadillo-400 Series WLAN Option Module (AWL12 Compatible): Determining Product Revision

The Armadillo-400 Series WLAN Option Module (AWL12 Compatible) consists of the Armadillo-WLAN Module (AWL12) and the Armadillo-400 Series WLAN Interface Board (AWL12 Compatible). The product revision can be determined from their lot numbers.

Please see Figure 1.13, “Armadillo-WLAN Module (AWL12) Lot Sticker Position” for the position of the lot sticker on the Armadillo-WLAN Module (AWL12).

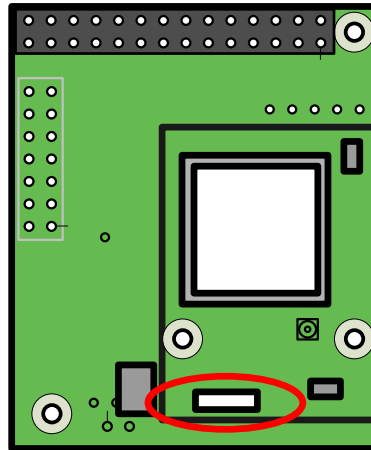

**Figure 1.13. Armadillo-WLAN Module (AWL12) Lot Sticker Position**

Of the six digits separated by a hyphen on the lot sticker, the left two digits are the lot number. Please see Figure 1.14, “Armadillo-WLAN Option Module (AWL12) Lot Sticker Format” for the position of the lot number. The lot number is written in hexadecimal.

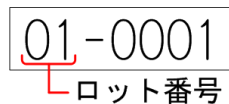

**Figure 1.14. Armadillo-WLAN Option Module (AWL12) Lot Sticker Format**

Please see Figure 1.15, “Armadillo-400 Series WLAN Interface Board (AWL12 Compatible) Lot Sticker Position” for the position of the lot sticker on the Armadillo-400 Series WLAN Interface Board (AWL12 Compatible).

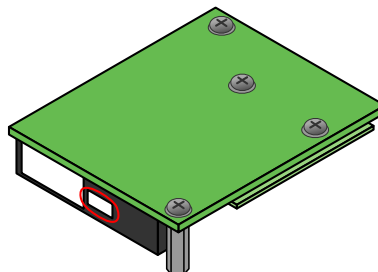

**Figure 1.15. Armadillo-400 Series WLAN Interface Board (AWL12 Compatible) Lot Sticker Position**

Of the six digits on the lot sticker, the middle two digits are the lot number. Please see Figure 1.16, “Armadillo-400 Series WLAN Interface Board (AWL12 Compatible) Lot Sticker Format” for the position of the lot number. The lot number is written in hexadecimal.



**Figure 1.16. Armadillo-400 Series WLAN Interface Board (AWL12 Compatible) Lot Sticker Format**

Please determine the product revision from the lot numbers of the Armadillo-WLAN Module (AWL12) and the Armadillo-400 Series WLAN Interface Board (AWL12 Compatible) using the table below.

Product Revision	Armadillo-WLAN Module (AWL12) Lot Number	Armadillo-400 Series WLAN Interface Board (AWL12 Compatible) Lot Number
A	01 and later	01 and later

### 1.2.8. Armadillo-400 Series WLAN Option Module (AWL13 Compatible): Determining Product Revision

The Armadillo-400 Series WLAN Option Module (AWL13 Compatible) consists of the Armadillo-WLAN Module (AWL13) and the Armadillo-400 Series WLAN Interface Board (AWL13 Compatible). The product revision can be determined from their lot numbers.

Please see Figure 1.17, “Armadillo-WLAN Module (AWL13) Lot Sticker Position” for the position of the lot sticker on the Armadillo-WLAN Module (AWL13).

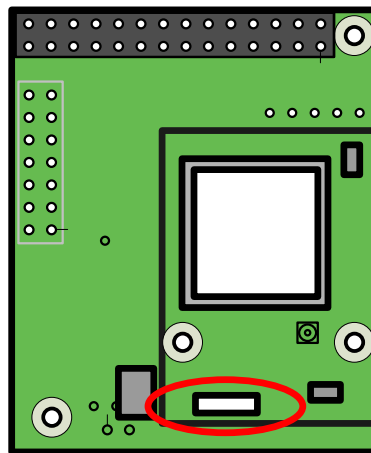

**Figure 1.17. Armadillo-WLAN Module (AWL13) Lot Sticker Position**

Of the six digits separated by a hyphen on the lot sticker, the left two digits are the lot number. Please see Figure 1.18, “Armadillo-WLAN Module (AWL13) Lot Sticker Format” for the position of the lot number. The lot number is written in hexadecimal.

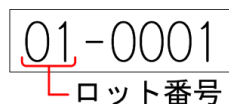

**Figure 1.18. Armadillo-WLAN Module (AWL13) Lot Sticker Format**

Please see Figure 1.19, “Armadillo-400 Series WLAN Interface Board (AWL13 Compatible) Lot Sticker Position” for the position of the lot sticker on the Armadillo-400 Series WLAN Interface Board (AWL13 Compatible).

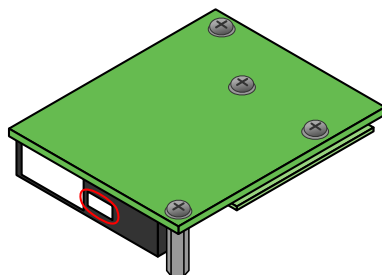

**Figure 1.19. Armadillo-400 Series WLAN Interface Board (AWL13 Compatible) Lot Sticker Position**

Of the six digits on the lot sticker, the middle two digits are the lot number. Please see Figure 1.20, “Armadillo-400 Series WLAN Interface Board (AWL13 Compatible) Lot Sticker Format” for the position of the lot number. The lot number is written in hexadecimal.



**Figure 1.20. Armadillo-400 Series WLAN Interface Board (AWL13 Compatible) Lot Sticker Format**

Please determine the product revision from the lot numbers of the Armadillo-WLAN Module (AWL13) and the Armadillo-400 Series WLAN Interface Board (AWL13 Compatible) using the table below.

Product Revision	Armadillo-WLAN Module (AWL13) Lot Number	Armadillo-400 Series WLAN Interface Board (AWL13 Compatible) Lot Number
A	01 and later	01 and later

# Chapter 2. Armadillo-420: Errata

---

## 2.1. Product Revision A

The following is errata information for Armadillo-420 product revision A. Please see each section for details on the errata.

- Section 2.1.1, “A420-Erratum #1: Current is Supplied to Connected USB Devices Even When PMIC is in OFF State”

### 2.1.1. A420-Erratum #1: Current is Supplied to Connected USB Devices Even When PMIC is in OFF State

#### 2.1.1.1. Description

Even when the PMIC is placed in the OFF state, as voltage is still supplied to any connected USB device current continues to flow to the device.

#### 2.1.1.2. Status

This erratum is fixed in product revisions D and later. For a workaround for this erratum, please refer to Section 2.1.1.3, “Management”.

The output state of +5V\_USB when the PMIC is in the OFF state before and after the fix is shown in the following table.

Power Supply Voltage	Before Fix	After Fix
+5V_USB	ON	OFF

#### 2.1.1.3. Management

To avoid this erratum, do not connect any USB devices when the PMIC is in the OFF state.

## 2.2. Product Revision B

The following is errata information for Armadillo-420 product revision B. Please see each section for details on the errata.

- Section 2.1.1, “A420-Erratum #1: Current is Supplied to Connected USB Devices Even When PMIC is in OFF State”

## 2.3. Product Revision C

The following is errata information for Armadillo-420 product revision C. Please see each section for details on the errata.

- Section 2.1.1, “A420-Erratum #1: Current is Supplied to Connected USB Devices Even When PMIC is in OFF State”

## 2.4. Product Revision D

There are no known errata for Armadillo-420 product revision D.

## 2.5. Product Revision E

There are no known errata for Armadillo-420 product revision E.

# Chapter 3. Armadillo-420: Revision History

---

## 3.1. Changes from Product Revision A to B

The following are changes made from product revision A to product revision B. Please see each section for details on the changes.

- Section 3.1.1, “USB and microSD Power Switch Changed”

### 3.1.1. USB and microSD Power Switch Changed

#### 3.1.1.1. Details

The power switch part used to control power supply to USB and microSD was changed. The reason for the change was to improve the availability of the power switch.

#### 3.1.1.2. Notes

There are no specification changes following from this change.

Section 2.1.1, “A420-Erratum #1: Current is Supplied to Connected USB Devices Even When PMIC is in OFF State” is not resolved with this change.

## 3.2. Changes from Product Revision B to C

The following are changes made from product revision B to product revision C. Please see each section for details on the changes.

- Section 3.2.1, “Changed to Eight Layer Board”
- Section 3.2.2, “microSD Power Switch Changed”
- Section 3.2.3, “Hardware ID Changed to 0x0302”

### 3.2.1. Changed to Eight Layer Board

#### 3.2.1.1. Details

The number of layers in the board was changed from six to eight.

#### 3.2.1.2. Notes

There are no specification changes following from this change.

### 3.2.2. microSD Power Switch Changed

#### 3.2.2.1. Details

The power switch part used to control power supply to microSD was changed. The reason for the change was to improve the availability of the power switch.

Following this change, the position of D7 (Schottky diode) on the board was also changed. Because of this, some connectors that could be fitted to CON13 on product revision B may interfere with D7 on product revision C and later and therefore cannot be used. For connectors that can be fitted to CON13, please refer to the "Armadillo-400 Series Hardware Manual".

### 3.2.2.2. Notes

There are no specification changes following from this change.

### 3.2.3. Hardware ID Changed to 0x0302

#### 3.2.3.1. Details

The hardware ID stored in the EEPROM was changed from 0x0301 to 0x0302.

#### 3.2.3.2. Notes

There are no specification changes following from this change.

## 3.3. Changes from Product Revision C to D

The following are changes made from product revision C to product revision D. Please see each section for details on the changes.

- Section 3.3.1, “USB and microSD Power Switch Changed”

### 3.3.1. USB and microSD Power Switch Changed

#### 3.3.1.1. Details

The power switch part used to control power supply to USB and microSD was changed. This change resolves Section 2.1.1, “A420-Erratum #1: Current is Supplied to Connected USB Devices Even When PMIC is in OFF State”.

#### 3.3.1.2. Notes

There are specification changes following from this change. Please refer to Section 2.1.1, “A420-Erratum #1: Current is Supplied to Connected USB Devices Even When PMIC is in OFF State” for details.

## 3.4. Changes from Product Revision D to E

The following are changes made from product revision D to product revision E. Please see each section for details on the changes.

- Section 3.4.1, “Mounting Factory Changed”

### 3.4.1. Mounting Factory Changed

#### 3.4.1.1. Details

The part mounting factory was changed in order to improve production capacity.

#### 3.4.1.2. Notes

There are no specification changes following from this change.



# Chapter 4. Armadillo-440: Errata

## 4.1. Product Revision A

The following is errata information for Armadillo-440 product revision A. Please see each section for details on the errata.

- Section 4.1.1, “A440-Erratum #1: Current is Supplied to Connected USB Devices Even When PMIC is in OFF State”

### 4.1.1. A440-Erratum #1: Current is Supplied to Connected USB Devices Even When PMIC is in OFF State

#### 4.1.1.1. Description

Even when the PMIC is placed in the OFF state, as voltage is still supplied to any connected USB device current continues to flow to the device.

#### 4.1.1.2. Status

This erratum is fixed in product revisions E and later. For a workaround for this erratum, please refer to Section 4.1.1.3, “Management”.

The output state of +5V\_USB when the PMIC is in the OFF state before and after the fix is shown in the following table.

Power Supply Voltage	Before Fix	After Fix
+5V_USB	ON	OFF

#### 4.1.1.3. Management

To avoid this erratum, do not connect any USB devices when the PMIC is in the OFF state.

## 4.2. Product Revision B

The following is errata information for Armadillo-440 product revision B. Please see each section for details on the errata.

- Section 4.1.1, “A440-Erratum #1: Current is Supplied to Connected USB Devices Even When PMIC is in OFF State”

## 4.3. Product Revision C

The following is errata information for Armadillo-440 product revision C. Please see each section for details on the errata.

- Section 4.1.1, “A440-Erratum #1: Current is Supplied to Connected USB Devices Even When PMIC is in OFF State”

## 4.4. Product Revision D

The following is errata information for Armadillo-440 product revision D. Please see each section for details on the errata.

- Section 4.1.1, “A440-Erratum #1: Current is Supplied to Connected USB Devices Even When PMIC is in OFF State”

## 4.5. Product Revision E

There are no known errata for Armadillo-440 product revision E.

## 4.6. Product Revision F

There are no known errata for Armadillo-440 product revision F.

# Chapter 5. Armadillo-440: Revision History

---

## 5.1. Changes from Product Revision A to B

The following are changes made from product revision A to product revision B. Please see each section for details on the changes.

- Section 5.1.1, “Test Pad Added”
- Section 5.1.2, “Hardware ID Changed to 0x0301”

### 5.1.1. Test Pad Added

#### 5.1.1.1. Details

A test pad for use in factory shipping tests was added. There were no specification changes to the board dimensions, parts or circuits.

#### 5.1.1.2. Notes

There are no specification changes following from this change.

### 5.1.2. Hardware ID Changed to 0x0301

#### 5.1.2.1. Details

The hardware ID stored in the EEPROM was changed from 0x0300 to 0x0301.

#### 5.1.2.2. Notes

Of the software that runs on Armadillo-440 product revision B, at least one of either the bootloader or the Linux kernel must have the version stated below.

- hermit-at version 2.0.1 (bootloader image file: loader-armadillo4x0-v2.0.1.bin) or later
- linux-2.6.26-at8 (Linux kernel image file: linux-a400-1.01.bin.gz) or later

## 5.2. Changes from Product Revision B to C

The following are changes made from product revision B to product revision C. Please see each section for details on the changes.

- Section 5.2.1, “USB and microSD Power Switch Changed”

### 5.2.1. USB and microSD Power Switch Changed

#### 5.2.1.1. Details

The power switch part used to control power supply to USB and microSD was changed. The reason for the change was to improve the availability of the power switch.

#### 5.2.1.2. Notes

There are no specification changes following from this change.

Section 4.1.1, “A440-Erratum #1: Current is Supplied to Connected USB Devices Even When PMIC is in OFF State” is not resolved with this change.

## 5.3. Changes from Product Revision C to D

The following are changes made from product revision C to product revision D. Please see each section for details on the changes.

- Section 5.3.1, “Changed to Eight Layer Board”
- Section 5.3.2, “microSD Power Switch Changed”
- Section 5.3.3, “Hardware ID Changed to 0x0302”

### 5.3.1. Changed to Eight Layer Board

#### 5.3.1.1. Details

The number of layers in the board was changed from six to eight.

#### 5.3.1.2. Notes

There are no specification changes following from this change.

### 5.3.2. microSD Power Switch Changed

#### 5.3.2.1. Details

The power switch part used to control power supply to microSD was changed. The reason for the change was to improve the availability of the power switch.

Following this change, the position of D7 (Schottky diode) on the board was also changed. Because of this, some connectors that could be fitted to CON13 on product revision C may interfere with D7 on product revision D and later and therefore cannot be used. For connectors that can be fitted to CON13, please refer to the "Armadillo-400 Series Hardware Manual".

#### 5.3.2.2. Notes

There are no specification changes following from this change.

### 5.3.3. Hardware ID Changed to 0x0302

#### 5.3.3.1. Details

The hardware ID stored in the EEPROM was changed from 0x0301 to 0x0302.

#### 5.3.3.2. Notes

There are no specification changes following from this change.

## 5.4. Changes from Product Revision D to E

The following are changes made from product revision D to product revision E. Please see each section for details on the changes.

- Section 5.4.1, “USB and microSD Power Switch Changed”

## **5.4.1. USB and microSD Power Switch Changed**

### **5.4.1.1. Details**

The power switch part used to control power supply to USB and microSD was changed. This change resolves Section 4.1.1, “A440-Erratum #1: Current is Supplied to Connected USB Devices Even When PMIC is in OFF State”.

### **5.4.1.2. Notes**

There are specification changes following from this change. Please refer to Section 4.1.1, “A440-Erratum #1: Current is Supplied to Connected USB Devices Even When PMIC is in OFF State” for details.

## **5.5. Changes from Product Revision E to F**

The following are changes made from product revision E to product revision F. Please see each section for details on the changes.

- Section 5.5.1, “Mounting Factory Changed”

### **5.5.1. Mounting Factory Changed**

#### **5.5.1.1. Details**

The part mounting factory was changed in order to improve production capacity.

#### **5.5.1.2. Notes**

There are no specification changes following from this change.

# Chapter 6. Armadillo-460: Errata

## 6.1. Product Revision A

The following is errata information for Armadillo-460 product revision A. Please see each section for details on the errata.

- Section 6.1.1, “A460-Erratum #1: Current is Supplied to Connected USB Devices Even When PMIC is in OFF State”

### 6.1.1. A460-Erratum #1: Current is Supplied to Connected USB Devices Even When PMIC is in OFF State

#### 6.1.1.1. Description

Even when the PMIC is placed in the OFF state, as voltage is still supplied to any connected USB device current continues to flow to the device.

#### 6.1.1.2. Status

The erratum is planned to be fixed in a future revision. For a workaround for this erratum, please refer to Section 6.1.1.3, “Management”.

The output state of +5V\_USB when the PMIC is in the OFF state is shown in the following table.

Power Supply Voltage	Before Fix
+5V_USB	ON

#### 6.1.1.3. Management

To avoid this erratum, do not connect any USB devices when the PMIC is in the OFF state.

## 6.2. Product Revision B

The following is errata information for Armadillo-460 product revision B. Please see each section for details on the errata.

- Section 6.1.1, “A460-Erratum #1: Current is Supplied to Connected USB Devices Even When PMIC is in OFF State”

# Chapter 7. Armadillo-460: Revision History

---

## 7.1. Changes from Product Revision A to B

The following are changes made from product revision A to product revision B. Please see each section for details on the changes.

- Section 7.1.1, “Mounting Factory Changed”

### 7.1.1. Mounting Factory Changed

#### 7.1.1.1. Details

The part mounting factory was changed in order to improve production capacity.

#### 7.1.1.2. Notes

There are no specification changes following from this change.

# Chapter 8. Armadillo-400 Series RTC Option Module (Product ID: OP-A400-RTCMOD-00): Errata

---

## 8.1. Product Revision A

There are no known errata for Armadillo-400 Series RTC Option Module (Product ID: OP-A400-RTCMOD-00) product revision A.



# Chapter 9. Armadillo-400 Series RTC Option Module (Product ID: OP-A400-RTCMOD-00): Revision History

---

There have been no changes to Armadillo-400 Series RTC Option Module (Product ID: OP-A400-RTCMOD-00).

# Chapter 10. Armadillo-400 Series RTC Option Module (Product ID: OP-A400-RTCMOD-01): Errata

---

## 10.1. Product Revision A

There are no known errata for Armadillo-400 Series RTC Option Module (Product ID: OP-A400-RTCMOD-01) product revision A.

# Chapter 11. Armadillo-400 Series RTC Option Module (Product ID: OP-A400-RTCMOD-01): Revision History

---

There have been no changes to Armadillo-400 Series RTC Option Module (Product ID: OP-A400-RTCMOD-01).

# Chapter 12. Armadillo-400 Series LCD Expansion Board: Errata

## 12.1. Product Revision A

The following is errata information for Armadillo-400 Series LCD Expansion Board product revision A. Please see each section for details on the errata.

- Section 12.1.1, “A400-LCD-Erratum #1: I2C Bus Becomes Unusable”
- Section 12.1.2, “A400-LCD-Erratum #2: i.MX257 AD Input Terminals Sustains Damage”

### 12.1.1. A400-LCD-Erratum #1: I2C Bus Becomes Unusable

#### 12.1.1.1. Description

There is a possibility that arbitration lost may occur on the I2C bus due to crosstalk noise on the FFC (Flexible Flat Cable) when the audio codec and real-time clock are used at the same time. Once this occurs, communication using the I2C bus will not be possible until rebooting.

#### 12.1.1.2. Status

This erratum is fixed in product revisions B and later. For a workaround for this erratum, please refer to Section 12.1.1.3, “Management”.

#### 12.1.1.3. Management

When designing an expansion board while referencing Armadillo-400 Series LCD Expansion Board product revision A, the following measures are recommended to avoid the crosstalk noise.

Target	Description
Pull-up resistor (R18) between I2C3_SCL and +3.3V	Change from 10kΩ to 1kΩ
Pull-up resistor (R20) between I2C3_SDA and +3.3V	Change from 10kΩ to 1kΩ
Between I2C3_SCL and GND	Add a 220pF condenser

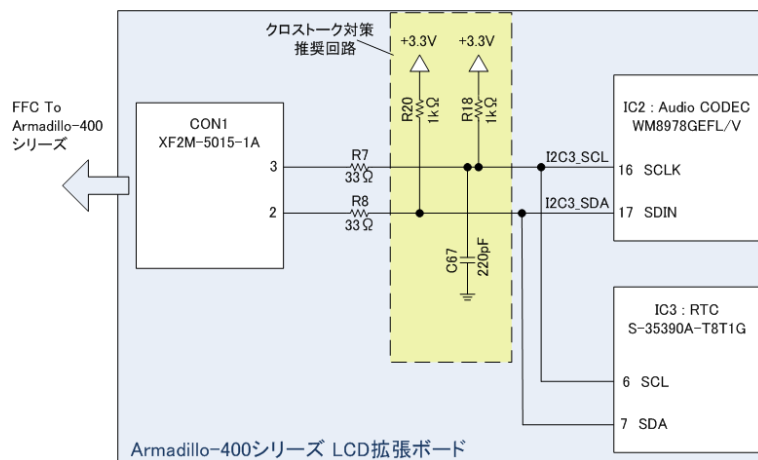

Figure 12.1. Recommended Circuit Measures for Crosstalk Noise

### 12.1.1.4. Notes

The RTC driver has been changed in linux-2.6.26-at10 (Linux kernel image file: linux-a400-1.03.bin.gz) and later in order to avoid arbitration lost on the I2C bus. The RTC driver change is not a fundamental fix and crosstalk noise may cause data reading and writing on the I2C bus to fail.

## 12.1.2. A400-LCD-Erratum #2: i.MX257 AD Input Terminals Sustains Damage

### 12.1.2.1. Description

As there is no input protection circuit on the touchscreen signals, if an ESD (ElectroStatic Discharge) occurs then the i.MX257 AD input terminals used for touchscreen input may be damaged.

### 12.1.2.2. Status

This erratum is fixed in product revisions B and later. For a workaround for this erratum, please refer to Section 12.1.2.3, "Management".

### 12.1.2.3. Management

When designing an expansion board while referencing Armadillo-400 Series LCD Expansion Board product revision A, the following measures are recommended to protect against ESD. With these measures, it is possible to mitigate the chance that the i.MX257 AD input terminals used for touchscreen input will be damaged.

Target	Description
<ul style="list-style-type: none"> <li>Between TOUCH_XP and CON2 (pin 37)</li> <li>Between TOUCH_XN and CON2 (pin 39)</li> <li>Between TOUCH_YP and CON2 (pin 38)</li> <li>Between TOUCH_YN and CON2 (pin 40)</li> </ul>	<ul style="list-style-type: none"> <li>Add a dumping resistor (33Ω)</li> <li>Add input protection circuits with external components (diodes etc)</li> </ul>

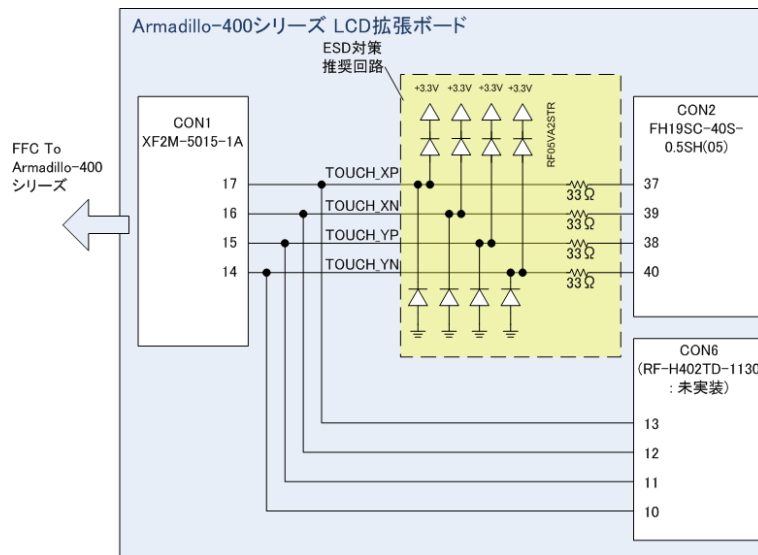

Figure 12.2. Recommended Circuit Measures for ESD

### 12.1.2.4. Notes

Adding dumping resistors will change the value applied to the i.MX257 AD input terminals used for touchscreen input. Because of this it will be necessary to perform a calibration of the touchscreen.



In atmark-dist-20100916 (userland image file: romfs-a440-1.03.img.gz) and later, touchscreen utilities (tslib-utils) have been added and `ts_calibrate` can be used to calibrate the touchscreen. Please follow the steps below to carry out the calibration.

1. Stop functester if it is running

```
[armadillo ~]# killall functester
```

2. Start the calibration by executing `ts_calibrate`. The touchscreen device file is specified for `TSLIB_TSDEVICE`.

```
[armadillo ~]# TSLIB_TSDEVICE=/dev/input/event1  
ts_calibrate
```

3. A screen like that shown below will be displayed. Please press the center of the cross cursor that is displayed. Do this five times to complete the calibration.

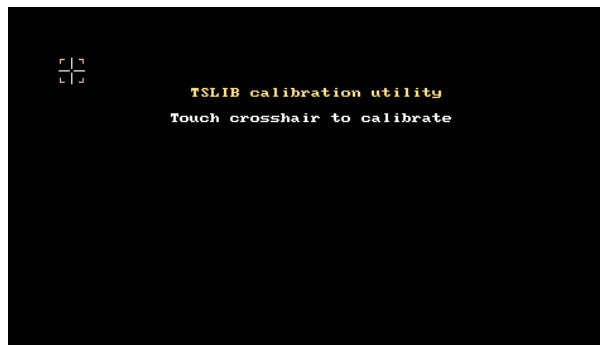

4. Please enter the following command to have the calibration results stay in effect after rebooting.

```
[armadillo ~]# flatfsd -s
```

## 12.2. Product Revision B

The following is errata information for Armadillo-400 Series LCD Expansion Board product revision B. Please see each section for details on the errata.

- Section 12.2.1, “A400-LCD-Erratum #3: Cannot Sleep When Used with linux-2.6.26-at13 and Previous Kernels”
- Section 12.2.2, “A400-LCD-Erratum #4: A Discrepancy in the Touchscreen Coordinates Occurs”

## 12.2.1. A400-LCD-Erratum #3: Cannot Sleep When Used with linux-2.6.26-at13 and Previous Kernels

### 12.2.1.1. Description

On product revision B, in order to fix Section 12.1.2, “A400-LCD-Erratum #2: i.MX257 AD Input Terminals Sustains Damage” the touchscreen inputs had ESD protection diodes added and were pulled up to +3.3V\_IO. If the +3.3V\_IO is turned off while in the sleep state the touch sensor electrical charge escapes through the diodes, and as this results in signal levels the same as when the touchscreen is pressed, as soon as the sleep state is entered the touchscreen interrupt occurs causing a wakeup.

### 12.2.1.2. Status

This was fixed in linux-2.6.26-at14. For a workaround for this erratum, please refer to Section 12.2.1.3, “Management”.

### 12.2.1.3. Management

Sleep state can be properly entered either by disabling the touchscreen input wakeup or by not turning off +3.3V\_IO at sleep time. linux-2.6.26-at14 and later kernels have been changed so that +3.3V\_IO is not turned off by default at sleep time. Please use linux-2.6.26-at14 or later kernels with the LCD Expansion Board product revision B.

## 12.2.2. A400-LCD-Erratum #4: A Discrepancy in the Touchscreen Coordinates Occurs

### 12.2.2.1. Description

On product revision B, in order to fix Section 12.1.2, “A400-LCD-Erratum #2: i.MX257 AD Input Terminals Sustains Damage” ESD protection diodes were added to the touchscreen inputs. This change causes the value applied to the i.MX257 AD input terminals used for touchscreen input to change, resulting in a discrepancy in the touchscreen coordinates.

### 12.2.2.2. Status

This has been fixed by storing touchscreen correcting values to the config region of the Armadillo-440 shipped with product revision B at shipping time.

If the config region is overwritten the coordinate discrepancy will occur. For measures for when this does happen, please refer to Section 12.2.2.3, “Management”.

### 12.2.2.3. Management

The touchscreen coordinate discrepancy can be corrected with the touchscreen utilities (tslib-utils). For information on using tslib-utils to make the correction, please refer to Section 12.1.2.4, “Notes” in Section 12.1.2, “A400-LCD-Erratum #2: i.MX257 AD Input Terminals Sustains Damage”.

### 12.2.2.4. Notes

Touchscreen input goes from the touchscreen, through the Linux device driver and then via a touch screen library (tslib) to the application.

The Armadillo-440 kernel has been tuned so that it presents correct coordinates for product revision A of the LCD Expansion Board. However, because of the changes to product revision B the values the kernel reads from the touchscreen are changed even for the same coordinates. On the default userland created with Atmark Dist, this change is compensated for in the tslib layer. The correction values are sorted in /etc/config/pointercal, and this file is saved in the config flash memory region.

On Armadillo-440 shipped with LCD Expansion Board product revision B, the correct `/etc/config/pointercal` file for product revision B is written to the config region at shipping time. If the config region is overwritten and the contents of `/etc/config/pointercal` changed, the compensation will be lost and the discrepancy in the coordinates will occur.



# Chapter 13. Armadillo-400 Series LCD Expansion Board: Revision History

---

## 13.1. Changes from Product Revision A to B

The following are changes made from product revision A to product revision B. Please see each section for details on the changes.

- Section 13.1.1, “A400-LCD-Erratum #1 Measures”
- Section 13.1.2, “A400-LCD-Erratum #2 Measures”
- Section 13.1.3, “RTC Backup Part Changed”

### 13.1.1. A400-LCD-Erratum #1 Measures

#### 13.1.1.1. Details

Circuits shown in Section 12.1.1.3, “Management” added for Section 12.1.1, “A400-LCD-Erratum #1: I2C Bus Becomes Unusable”.

#### 13.1.1.2. Notes

None.

### 13.1.2. A400-LCD-Erratum #2 Measures

#### 13.1.2.1. Details

The following changes were made as measures for Section 12.1.2, “A400-LCD-Erratum #2: i.MX257 AD Input Terminals Sustains Damage”

- Added circuits shown in Section 12.1.2.3, “Management”
- Moved the position of CON6 (General Purpose LCD Interface) under the LCD<sup>[1]</sup>

#### 13.1.2.2. Notes

Discrepancy in the touchscreen coordinates will occur in either of the following situations.

- Using product revision B with Armadillo-440 calibrated for product revision A
- Using product revision A with Armadillo-440 calibrated for product revision B

For the steps to carry out touchscreen calibration, please refer to Section 12.1.2.4, “Notes”.

### 13.1.3. RTC Backup Part Changed

#### 13.1.3.1. Details

The part used for RTC backup was changed from an electric double layer capacitor to a laminated ceramic capacitor. The representative specifications of the parts used are shown in the following table.

---

<sup>[1]</sup>Moved to mitigate chance of ESD occurring.

Product Revision	Used Part	Backup Time	Lifespan
A	Electric double layer capacitor 0.2F	5 day (reference value, 25°C) <sup>[a]</sup>	5600 hours (25°C) 500 hours (60°C)
B	Laminated ceramic capacitor 47µF	300 seconds (TYP, 25°C) 60 seconds (MIN)	No limit

<sup>[a]</sup>Backup times are reference values. The backup time of the electric double layer capacitor is greatly affected by environmental temperature and voltage application time.

### 13.1.3.2. Notes

None.

# Chapter 14. Armadillo-400 Series WLAN Option Module (AWL12 Compatible): Errata

---

## 14.1. Product Revision A

There are no known errata for Armadillo-400 Series WLAN Option Module (AWL12 Compatible) product revision A.

# Chapter 15. Armadillo-400 Series WLAN Option Module (AWL12 Compatible): Revision History

---

There have been no changes to Armadillo-400 Series WLAN Option Module (AWL12 Compatible).

# Chapter 16. Armadillo-400 Series WLAN Option Module (AWL13 Compatible): Errata

---

## 16.1. Product Revision A

There are no known errata for Armadillo-400 Series WLAN Option Module (AWL13 Compatible) product revision A.

# Chapter 17. Armadillo-400 Series WLAN Option Module (AWL13 Compatible): Revision History

---

There have been no changes to Armadillo-400 Series WLAN Option Module (AWL13 Compatible).

### Revision History

Revision	Date	Description
1.0.0	10/29/2010	<ul style="list-style-type: none"> <li>Initial Release</li> </ul>
1.1.0	12/20/2010	<ul style="list-style-type: none"> <li>Updates for Armadillo-400 Series LCD Expansion Board Product Revision B</li> <li>Updates for Armadillo-400 Series RTC Option Module (Product ID: OP-A400-RTCMOD-01)</li> <li>Updates for Armadillo-400 Series WLAN Option Module</li> <li>Section 12.1.2.4, “Notes” atmark-dist version error correction</li> </ul>
1.1.1	03/25/2011	<ul style="list-style-type: none"> <li>Updated company address</li> </ul>
1.1.2	05/23/2011	<ul style="list-style-type: none"> <li>Armadillo-420 product revision and corresponding lot number error correction.</li> </ul> <p>Incorrect:</p> <ul style="list-style-type: none"> <li>Lot numbers 01 and later are product revision A</li> </ul> <p>Correct:</p> <ul style="list-style-type: none"> <li>Lot numbers 01 to 06 are product revision A</li> <li>Lot number 07 is product revision B</li> <li>Lot numbers 08 and later are product revision C</li> </ul> <ul style="list-style-type: none"> <li>Armadillo-440 product revision and corresponding lot number error correction.</li> </ul> <p>Incorrect:</p> <ul style="list-style-type: none"> <li>Lot numbers 02 and later are product revision B</li> </ul> <p>Correct:</p> <ul style="list-style-type: none"> <li>Lot numbers 02 to 0F are product revision B</li> <li>Lot numbers 10 to 12 are product revision C</li> <li>Lot numbers 13 and later are product revision D</li> </ul> <ul style="list-style-type: none"> <li>Armadillo-400 Series LCD Expansion Board product revision and corresponding lot number error correction.</li> </ul> <p>Incorrect:</p> <ul style="list-style-type: none"> <li>Lot numbers 07 and later are product revision B</li> </ul> <p>Correct:</p> <ul style="list-style-type: none"> <li>Lot numbers 06 and later are product revision B</li> </ul>
1.2.0	07/13/2011	<ul style="list-style-type: none"> <li>Updates for Armadillo-460</li> <li>Added notes about Section 12.2.1, “A400-LCD-Erratum #3: Cannot Sleep When Used with linux-2.6.26-at13 and Previous Kernels”.</li> <li>Added notes about Section 12.2.2, “A400-LCD-Erratum #4: A Discrepancy in the Touchscreen Coordinates Occurs”.</li> </ul>
1.2.1	08/26/2011	<ul style="list-style-type: none"> <li>Added precautions related to CON13 to Chapter 3, Armadillo-420: Revision History/Section 3.2, “Changes from Product Revision B to C”/Section 3.2.2, “microSD Power Switch Changed”/Section 3.2.2.2, “Notes” and Chapter 5, Armadillo-440: Revision History/Section 5.3, “Changes from Product Revision C to D”/Section 5.3.2, “microSD Power Switch Changed”/Section 5.3.2.2, “Notes”.</li> <li>Made corrections to Section 12.2.2, “A400-LCD-Erratum #4: A Discrepancy in the Touchscreen Coordinates Occurs”/Section 12.2.2.2, “Status”.</li> </ul>
1.3.0	12/21/2011	<ul style="list-style-type: none"> <li>With the release of AWL13, specified the module name (AWL12) in all product names related to AWL12</li> </ul>

- Added information on AWL13
- Added product revisions D and E to Section 1.2.1, “Armadillo-420: Determining Product Revision”
- Corrected lot numbers for product revisions B and C in Section 1.2.2, “Armadillo-440: Determining Product Revision”.
- Added product revisions E and F to Section 1.2.2, “Armadillo-440: Determining Product Revision”
- Added product revision B to Section 1.2.3, “Armadillo-460: Determining Product Revision”
- Added Section 2.1.1, “A420-Erratum #1: Current is Supplied to Connected USB Devices Even When PMIC is in OFF State”
- Added Section 4.1.1, “A440-Erratum #1: Current is Supplied to Connected USB Devices Even When PMIC is in OFF State”
- Added Section 6.1.1, “A460-Erratum #1: Current is Supplied to Connected USB Devices Even When PMIC is in OFF State”
- Corrected various errors



Armadillo-400 Series Revision Information  
Version 1.3.0  
2012/02/29

---

**Atmark Techno, Inc**  
060-0035 AFT Bldg., N5E2, Chuo-ku, Sapporo TEL 011-207-6550 FAX 011-207-6570

---